

LED Profiler

IMS-5000

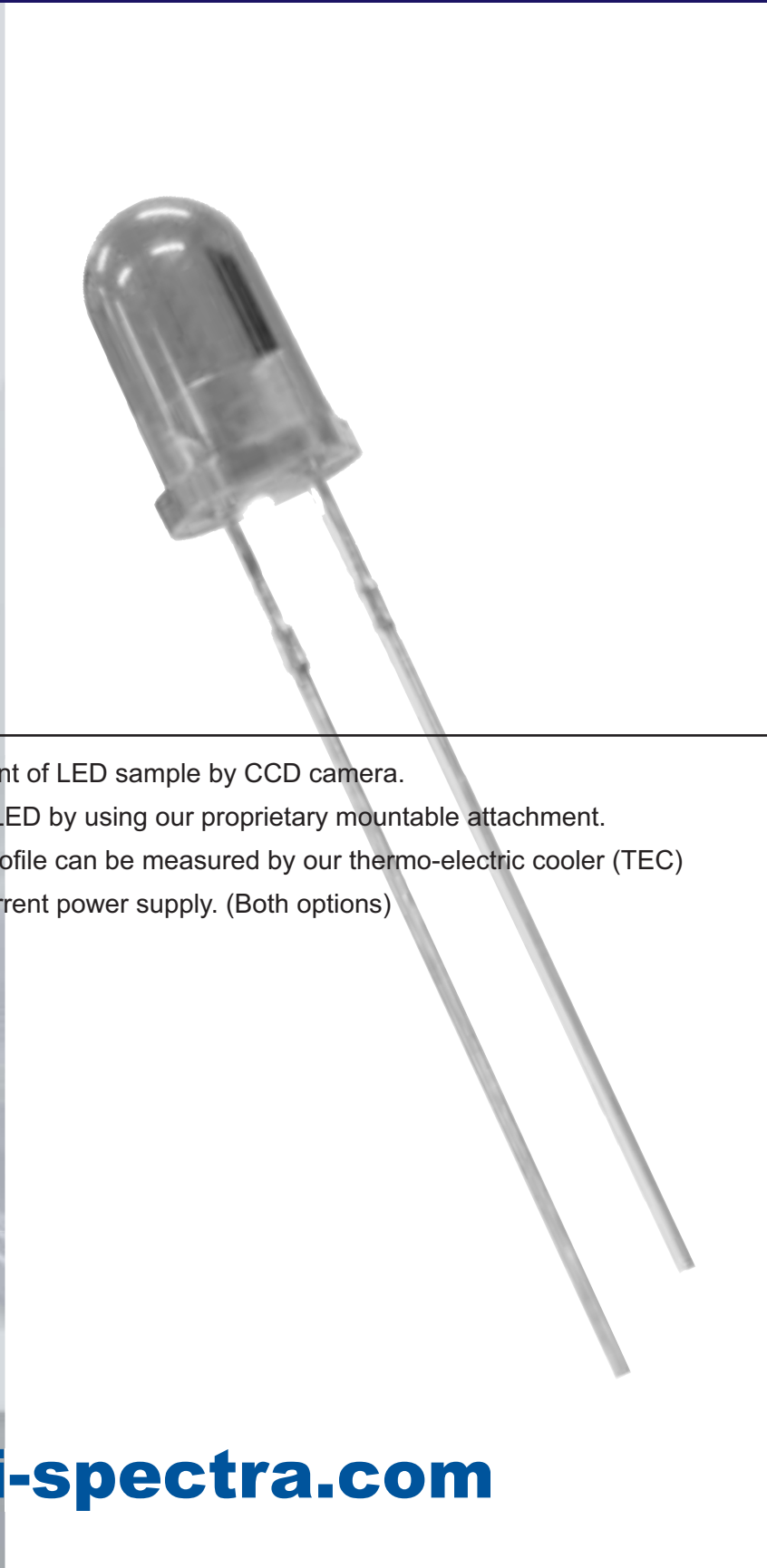

Features

- I) Precise alignment of LED sample by CCD camera.
- II) Easy setting of LED by using our proprietary mountable attachment.
- III) Genuine LED profile can be measured by our thermo-electric cooler (TEC) and constant current power supply. (Both options)



Software

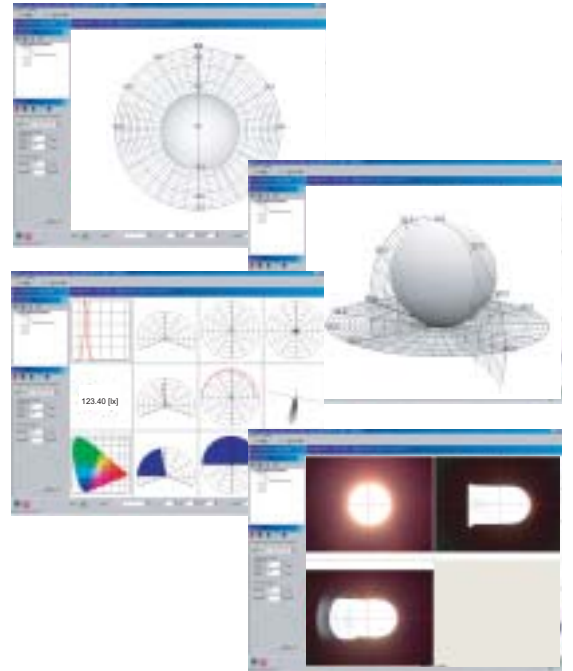
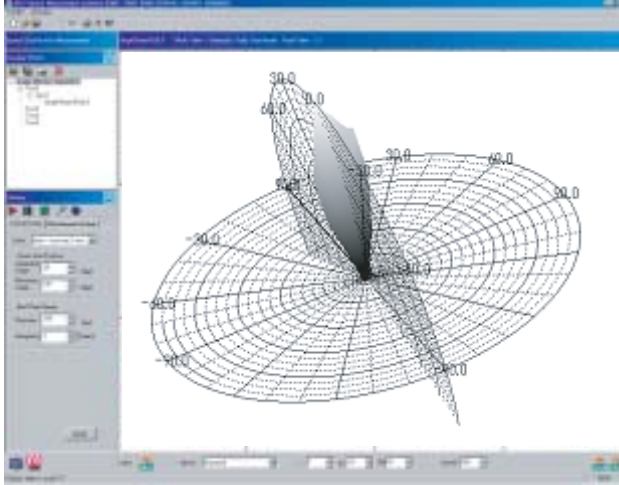

The proprietary software can show various types of graphs such as spectroradiometry, photometry, or colorimetry with 2D/3D polar/rectangular view.

Easy-Mountable attachment for LEDs

Recently many kinds of LEDs with various size are available as LEDs market is growing up. We will offer two typical mountable attachments as standard set and they must help your easy mounting. Also any custom attachments available through Asahi Spectra. For more detail please contact us, info@asahi-spectra.com



- Standard Set**
- Oval LED, 3mm diameter
 - Oval LED, 5mm diameter

*Easy-mountable attachment for SMT LEDs available.

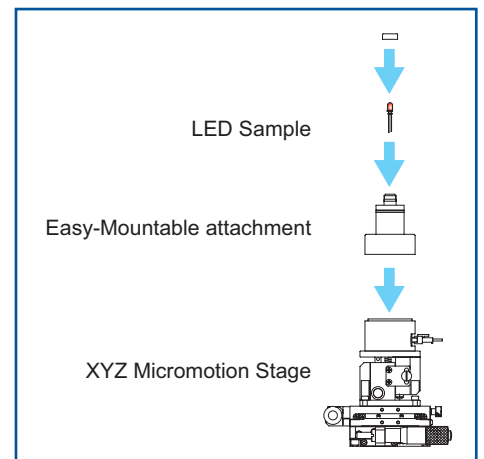

Actual example

1. Sample: Oval LED 5mm diameter (Green)

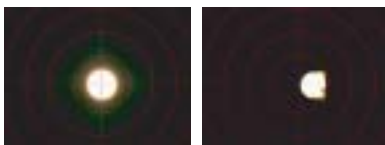

2. Sample: SMT LED (White)

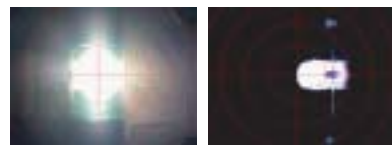

LED Profiler, IMS-5000 has released by Asahi Spectra as the most powerful instrument to evaluate unknown LED output characteristics among similar devices. The IMS-5000 can measure a spacial distribution in terms of spectral performance, illuminance, and CIE chromaticity of any illuminating object including but not limited LED. All operations are controlled by PC and the measurement is automatic.

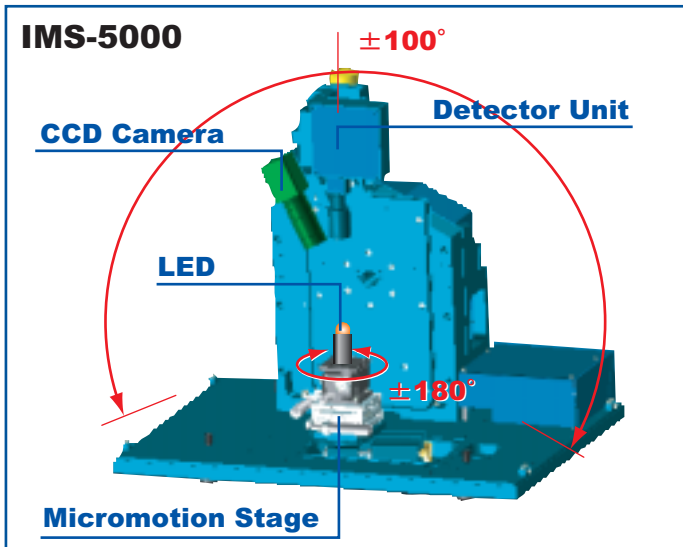

CCD Camera

As precise positioning is one of the most important factor to measure the sample, the IMS-5000 allow real time alignment of the sample while watching the PC monitor as seen from the CCD camera.

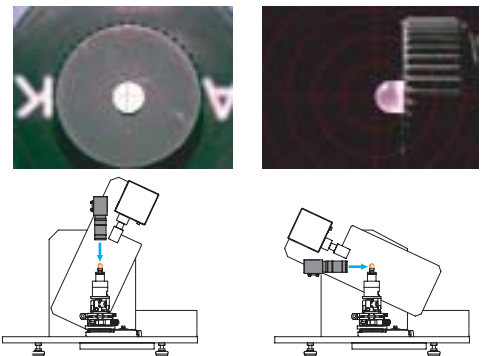

	Optical Property	Spatial Distribution (2D Polar View)	Spatial Distribution (3D Polar View)	Others
Spectroradiometry				<ul style="list-style-type: none"> - Peak Wavelength [nm] - Center Wavelength [nm] - FWHM [nm] - Spectral irradiance [$\mu\text{W}/\text{m}^2$]
Photometry	123.40 [lx]			<ul style="list-style-type: none"> - Illuminance [lx] - Luminous Intensity [cd]
Colorimetry				<ul style="list-style-type: none"> - Tristimulus Value (X, Y, Z) - Chromaticity Diagram (x, y) - Dominant Wavelength [nm] - Color Purity [%] - Correlated Color Temperature [K]

Standard Set

- LED Profiler
- Software (CD-ROM)
- Grating Polychromator for VIS (350-850nm)
- Communication Cable
- AC Cable
- Easy-Mountable attachments for oval LED with 3mm/5mm diameter
- CCD camera for positioning
- XYZ micromotion stage
- Desktop PC (Preinstalled Win XP, MS Office, and IMS-5000 Software)
- LCD Display (17 inch)

Accessories

- Printer
- Any kinds of Easy-Mountable Attachment (SMT LEDs or others)
- Thermo-electric cooler (**Recommended**)
- Constant Current Power Supply (**Recommended**)
- Grating Polychromator for UV (250-740nm)
- Grating Polychromator for NIR (530-1000nm)
- Bandpass Filter
- Neutral Density Filter
- Exclusive Counter

Specifications

Model : IMS5000
 Detector Unit : Grating Polychromator
 : Single, Czerny-Turner
 Focal Length : 75mm
 F-number : 5.6
 Wavelength : 350-850nm
 Resolution : 5.5nm at 546.1nm
 Wavelength Precision : +/-1.2nm
 Wavelength Reproducibility : +/-0.6nm
 Stray Light : 0.1%
 Sensor : NMOS (Linear Image Sensor ,1024 elements)
 Exposure Time : 20 msec - 30 sec

Minimum Measurable Angle : Detector Arm 1 degree
 : Stage 1 degree
 Operational Range : Detector Arm +/-100 degree
 : Stage +/-180 degree
 Method of Scanning : Step Scan
 Stage : XYZ Micromotion Stage
 : X-axis Direction Stroke +/-12.5mm (Manual)
 : Y-axis Direction Stroke +/-12.5mm (Manual)
 : Z-axis Direction Stroke +/-5mm (Manual)
 XYZ Indication : Analog Indication by Micrometer

Input Voltage : AC85V - 264V 50/60Hz
 Power Consumption : 80VA
 Interface : RS485

Environmental Conditions : Temperature 5-35 degree celsius
 (Operating within performance specifications) : Humidity 20-80% (non-condensing)
 Dimensions : 630(W) x 382(D) x 595(H) mm
 Weight : 64 kg

Basic example of Custom Attachment

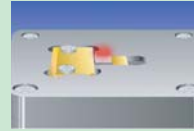

Mountable attachment
Type-A

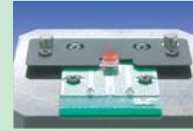

Mountable attachment
Type-B



Mountable attachment
Type-C



Mountable attachment
Type-D
(Oval Type)



Mountable attachment
Type-E

TOP

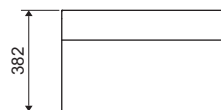

Front

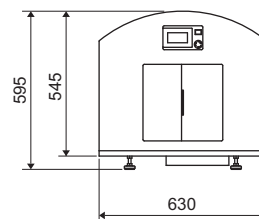

Side

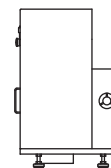

Back

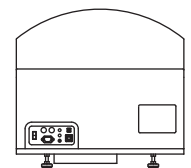

Units : mm

*We accept no responsibility for any errors or omissions, and we reserve the right to modify design, characteristics and products at any time without obligation.

ASAHI SPECTRA^{USA}

23505 Crenshaw Blvd., Suite 229 Torrance, CA 90505 USA

TEL : 310.530.5855 / FAX : 310.325.8974

Email : info@asahi-spectra.com

www.asahi-spectra.com